

UV INKJET PRINTER

# *UJV200-130 / 160*

## Safety Precautions

# Safety Precautions

You can also download the latest manual from official website.

MIMAKI ENGINEERING CO., LTD.

<https://mimaki.com/>

D203922-11  
Original instructions

# TABLE OF CONTENTS

---

Introduction .....	3
To Ensure Safe Use .....	5
Symbols .....	5
Usage Precautions .....	6
Notes on Handling Ink or any Other Liquid Used with the Machine .....	10
Restrictions Concerning the Expiration Date of Ink Used in the Machine .....	12
Installation Precautions.....	13
Installation Space .....	14
When relocating the machine .....	14
Safety Interlocks .....	15
Warning Label.....	16

# Introduction

Thank you for purchasing the Inkjet printer JV200-160B, CJV200-160B.

Read the safety precautions ("this document" hereinafter) thoroughly and make sure you understand its contents to ensure safe and correct use of the product.

Please note that the illustrations contained in this manual are intended to show functions, procedures, or operations and may sometimes differ slightly from the actual machine.

Unauthorized reproduction of any portion of this document is strictly prohibited.

© 2025 MIMAKI ENGINEERING Co., Ltd.

## ● DISCLAIMERS

- MIMAKI ENGINEERING REJECTS ALL LIABILITY FOR DAMAGE ARISING DIRECTLY OR INDIRECTLY FROM THE USE OF THE JV200-160B, CJV200-160B ("THIS MACHINE" HEREINAFTER), WHETHER OR NOT THE PRODUCT IS FAULTY.
- MIMAKI ENGINEERING REJECTS ALL LIABILITY FOR DAMAGE, DIRECT OR INDIRECT, TO MATERIALS CREATED WHILE USING THIS MACHINE.
- USING THIS MACHINE IN CONJUNCTION WITH DEVICES OTHER THAN THOSE RECOMMENDED BY MIMAKI ENGINEERING MAY RESULT IN FIRE OR ACCIDENTS. SUCH INCIDENTS ARE NOT COVERED BY THE PRODUCT WARRANTY. MIMAKI ENGINEERING REJECTS ALL LIABILITY FOR DAMAGE, DIRECT OR INDIRECT, ARISING FROM SUCH INCIDENTS.
- USE ONLY GENUINE MIMAKI ENGINEERING INK AND MAINTENANCE LIQUID. USE OF OTHER PRODUCTS MAY RESULT IN FAILURES OR REDUCE PRINT QUALITY. SUCH INCIDENTS ARE NOT COVERED BY THE PRODUCT WARRANTY. MIMAKI ENGINEERING REJECTS ALL LIABILITY FOR DAMAGE, DIRECT OR INDIRECT, ARISING FROM SUCH INCIDENTS.
- DO NOT ATTEMPT TO REFILL THE INK BOTTLES WITH UNAUTHORIZED INK. SUCH INCIDENTS ARE NOT COVERED BY THE PRODUCT WARRANTY. MIMAKI ENGINEERING REJECTS ALL LIABILITY FOR DAMAGE, DIRECT OR INDIRECT, ARISING FROM SUCH INCIDENTS.
- AVOID USING UV-LED UNITS OR UV POWER SUPPLY UNITS OTHER THAN THOSE SPECIFIED BY MIMAKI ENGINEERING. USING DEVICES OTHER THAN GENUINE MIMAKI ENGINEERING DEVICES MAY RESULT IN FAILURE, ELECTRIC SHOCK, OR FIRE. SUCH INCIDENTS ARE NOT COVERED BY THE PRODUCT WARRANTY. MIMAKI ENGINEERING REJECTS ALL LIABILITY FOR DAMAGE, DIRECT OR INDIRECT, ARISING FROM SUCH INCIDENTS.

## ● TV and radio interference



- The machine emits high-frequency electromagnetic radiation while operating. Under certain circumstances, this may result in TV or radio interference. We make no guarantee that this machine will not affect special radio or TV equipment.
- 

If radio or TV interference occurs, check the radio or TV reception after turning off the machine. If the interference disappears when the power is turned off, the machine is likely to be the cause of the interference.

Try any of the following solutions or combinations of these solutions:

- Change the orientation of the TV or radio antenna to find a position where interference does not occur.
- Move the TV or radio away from this machine.
- Plug the TV or radio into a power outlet on a power circuit other than the power circuit to which this machine is connected.

## ● FCC (Federal Communications Commission) regulations

The machine has been tested and certified to comply with restrictions applying to Class A digital devices under Part 15 of the FCC regulations. These restrictions are designed to provide suitable protection from harmful interference when the printer is used in commercial environments.

This product may generate, use, or emit radio frequency energy and may cause harmful interference with radio communications if not installed or used in accordance with the operating manual.

Use of this product in residential areas may cause harmful interference. If so, the user is responsible for rectifying such interference.

---











- Use only the cables recommended by Mimaki Engineering when connecting to the machine. Use of other cables may cause the product to exceed the restrictions stipulated by FCC regulations. To maintain compliance with FCC regulations, use the cables recommended by Mimaki Engineering.
-

# To Ensure Safe Use

## Symbols

In this manual, symbols indicate and explain precautions. Make sure you fully understand the meaning of each symbol and use the machine safely and correctly.

Explanation		
 <b>WARNING</b>	Warning	Indicates a potential hazard that may result in death or serious injury if handled improperly or if instructions are disregarded.
 <b>CAUTION</b>	Caution	Indicates a potential hazard that may result in minor or moderate injury if handled improperly or if instructions are disregarded.
 <b>NOTICE</b>	Notice	Indicates a potential hazard that may result in property damage if handled improperly or if instructions are disregarded.
	Warning sign	Indicates something that requires attention. Warning specifics are drawn inside the symbol.
	Mandatory action sign	Indicates an action that must be carried out. The specifics of the mandatory action are drawn inside the symbol.
	Prohibition sign	Indicates a prohibited action. The specifics of the prohibited action are drawn inside the symbol.
 <b>Important!</b>	Important	Indicates important information related to use of this machine.
	Tip	Indicates useful reference information.
	Reference information	Indicates the corresponding page for related information.

## Usage Precautions

### ● In the event of abnormal conditions

#### WARNING



- In the event of abnormal conditions such as smoke or unusual odor, turn off the main power immediately and unplug the power cable. Continuing to use the machine under these conditions may result in failure, electric shock, or fire. Once you have confirmed that smoke is no longer being emitted, contact your local dealer or our service office. Never attempt to repair the machine yourself, which is hazardous.

#### CAUTION



- Immediately wipe off any ink, maintenance liquid, waste ink, or other liquid used with the product that comes into contact with your skin. Then wash using soap, and rinse with plenty of water. Failure to wash off ink may result in skin inflammation. If your skin becomes irritated or painful, seek medical attention immediately.
- If ink, maintenance liquid, waste ink, or any other liquid used in the product comes into contact with your eyes, rinse immediately with plenty of clean water. Rinse for at least 15 minutes. If you wear contact lenses and they can be easily removed, remove after rinsing for at least 15 minutes with clean water. Be sure to also rinse the undersides of your eyelids. Failure to rinse off ink may result in blindness or impaired vision. If your eyes become irritated or painful, seek medical attention immediately.
- If ink, maintenance liquid, waste ink, or any other liquid used in the product enters your mouth or is swallowed, gargle with water immediately. Do not induce vomiting. Seek medical attention promptly. Inducing vomiting may cause liquid to enter the airway.
- If a large amount of vapor is inhaled, move to a well-ventilated area, keep warm, and rest in a posture that allows easy breathing. If the condition does not improve, seek medical attention promptly.

#### NOTICE



- If an ink leak occurs, turn off the main power immediately and unplug the power cable. Then, contact your local dealer or our service office.

## ● Power supply precautions

### ⚠ WARNING



- Use the power cable provided. Otherwise there is a risk of failure, electric shock, or fire. The power cable provided is exclusive for the machine, and must not be used for other electrical equipment.
- Always hold the plug when removing the power cable. Pulling out the power cable may damage the cable, leading to failure, electric shock, or fire.
- Do not use the machine with dust accumulated on the power plug. Otherwise there is a risk of failure, electric shock, or fire.
- Take care to prevent metals from touching the power plug blades. Otherwise there is a risk of failure, electric shock, or fire.
- Do not damage or modify the power cable. Do not place heavy objects on, heat or stretch it. Doing so may damage the cable, leading to electric shock or fire.
- Do not use extension cords or power strips. Otherwise there is a risk of failure, electric shock, or fire.
- Do not use the power cable if it is damaged or broken or if the core wire is exposed. Otherwise there is a risk of failure, electric shock, or fire.
- Do not handle the power plug with wet hands. Disregarding this precaution may result in electric shock.



- Plug the power cable plug into a grounded power outlet. Otherwise there is a risk of failure, electric shock, or fire.
- When installing electrical outlets, perform grounding work to prevent electric shock. All electrical work (Class C grounding work; formerly Type 3 grounding work) must be handled by a licensed electrician.

### NOTICE



- Do not turn off the main power supply. Turning off the main power supply will disable the automatic maintenance function (including nozzle clogging prevention function and ink discharge channel cleaning function). This increases the risk of ejection failures (such as nozzle clogging or deflection).

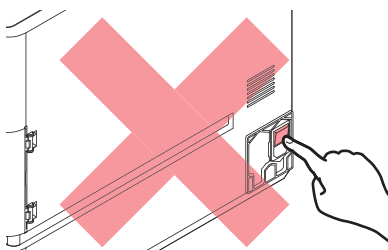

- Use the machine with a power supply that meets specifications.
- Be sure to plug the power cable into a power outlet close to the machine. Insert the power plug blade securely.
- When connecting the power cable, check the input voltage of the power outlet and the capacity of the breaker. Also, connect each cable to a separate power source with an independent breaker. Connecting to power outlets linked with the same breaker will cause the breaker to trip.

## ● Caution regarding moving parts

### CAUTION



- Keep parts of the body such as the face and hands away from moving parts. Also keep clothing (e.g., loose clothing and accessories) that may impede work away from the machine. Failure to do so may result in injury.



- Long hair should be tied back. Failure to do so may result in injury.

## ● Do not disassemble or repair

### WARNING



- Do not attempt to disassemble or repair this machine. Otherwise there is a risk of failure, electric shock, or fire.

## ● Handling the cutter

### CAUTION



- Avoid touching the cutter blade. Failure to do so may result in injury.
- Do not shake or swing the cutter holder. Doing so may cause the blade to come off.

## ● Heater

### CAUTION



- The heater becomes extremely hot. Do not touch with bare hands.

### NOTICE

## ● Ultraviolet light (UV) and the UV-LED unit

### WARNING



- Do not place combustibles under the UV-LED unit, and do not cover it with paper or cloth. There is a risk of fire or burns.
- Small amounts of ultraviolet light may leak from the UV-LED unit. Wear UV safety glasses, Interface shields, masks, gloves, and long-sleeved clothing to protect the eyes and skin from ultraviolet light.
  - (1) Exposure to ultraviolet light may result in skin inflammation. Even if no inflammation occurs, extended or repeated exposure may lead to chronic problems.
    - Acute problems: Inflammation
    - Chronic problems: Skin cancer, wrinkles, blotches
  - (2) Looking directly at the lamp while the lamp is on may result in eye pain or damage to eyesight. Even if no eye pain occurs, extended or repeated exposure may lead to chronic problems.
    - Acute problems: Ultraviolet keratitis, conjunctivitis, discomfort, pain, watery eyes
    - Chronic problems: Pterygium, cataracts

### CAUTION



- The UV-LED unit becomes extremely hot. Be careful not to touch the LED after it has been turned off until it has sufficiently cooled.



- Do not expose the skin or eyes directly or indirectly to light from the UV-LED unit. The UV-LED unit emits ultraviolet (UV) light. Skin or eye exposure may result in inflammation.



- Be sure to use the UV safety glasses provided. May cause eye pain and vision problems.

### NOTICE



- Avoid scratching or subjecting the UV-LED unit to excessive force. Disregarding this precaution may result in deformation or failure of the unit.
- Avoid touching the glass on the underside of the UV-LED unit with bare hands. Disregarding this precaution may impair UV ink curing. If the glass becomes dirty, wipe clean using a soft, clean cloth soaked with ethanol. Be careful to keep ethanol from splashing on the covers or other parts while cleaning. Disregarding this precaution may result in deformation or failure of the unit.

### ● Other usage precautions

#### WARNING



- Keep children away from the machine.

### NOTICE



- Do not pull the media when the clamp lever is lowered (the media is clamped). Doing so may damage the machine.



- The underside of the media may be soiled depending on how the printed media has been stored (due to weight when laying printed media rolls horizontally, for example) and the media type. Perform a test beforehand to check that the media does not transfer ink to the underside of the adjacent media.

### ● Disposing of the product

#### CAUTION



- Please contact your local retailer or service agent.
- When disposing of the product yourself, contact an industrial waste disposal operator or dispose of the product in accordance with local laws and regulations.

# Notes on Handling Ink or any Other Liquid Used with the Machine

Precautions regarding ink, maintenance liquid, or other liquids used with this machine are included with the containers. Thoroughly read them and make sure you understand the contents.



- Be sure to read the safety data sheet (SDS) before use. <https://mimaki.com/supply/sds/>

## CAUTION



- Pay close attention to ventilation and be sure to wear safety glasses, gloves, and a mask when handling ink, maintenance liquid, waste ink, or other solutions used with the machine. Leaking ink may adhere to the skin or get into the eyes or mouth.



- Do not subject cases containing ink to strong shock or violent shaking. Do not attempt to refill the ink. Leaking ink may adhere to the skin or get into your eyes or mouth.



- Do not disassemble cases containing ink. Leaking ink may adhere to the skin or get into your eyes or mouth.



- Do not store ink, maintenance liquid, or other liquids used with the machine in locations where children may enter.



- When disposing of ink, maintenance liquid or other liquid used with the product, or containers or non-woven fabric contaminated with ink or other liquid, contact an industrial waste disposal operator or dispose of the product in accordance with the local laws and regulations.

## NOTICE



- Do not store ink, maintenance liquid, or other liquids used with the machine in locations exposed to direct sunlight.
- Do not store ink, maintenance liquid, or other liquids used with the machine in environments where cutting fluid or other volatile substances (such as amines or modified amine alcohol) are present in significant quantities. Storage in such places increases the risk of failure or ejection failures (e.g., nozzle clogging or deflection).
- Do not use ink, maintenance liquid, or other liquids used with this machine with other printers. Doing so may cause failure.



- Be sure to store them in a low place no higher than 1 m above the floor. Otherwise there is a risk of scattering if the containers fall.
- Store in tightly sealed containers.
- Store in a cool, dark place.
  - (1) Store ink in a place where ink does not freeze. Using defrosted ink may deteriorate ink constituents and reduce print quality.
  - (2) When ink is moved from a cold place to a warm place, leave it in the environment where the machine is installed for at least three hours before using it.
  - (3) Open the container just before installing it, and use it up as quickly as possible. If it is opened and left for an extended period of time, print quality may be reduced.



- Do not touch the metal parts of the ink IC chip. Static electricity may damage the ink IC chip, and dirt or damage may cause the ink IC chip read error.



- Printing is not possible when different types of ink IC chips are used.
- If the ink bottle mounted on the machine is dented, it may still be used.

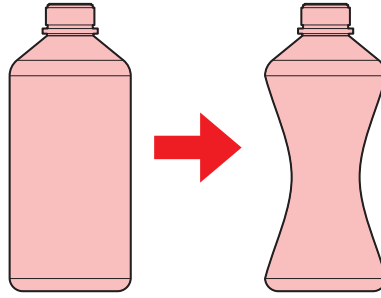

## Restrictions Concerning the Expiration Date of Ink Used in the Machine

Example: When the expiration date is April 20xx

- May 20xx: Replace with new ink or use up as quickly as possible. Printing is possible.
- June 20xx: Replace with new ink or use up as quickly as possible. Printing is possible.
- July 20xx: Printing is not possible.



- The message appears on the display.



- The ink expiration date is indicated on the ink container. Expired ink may cause ejection failures or alter the color tone. Printing is possible even if the ink has passed its expiration date. Nevertheless, we recommend replacing with new ink or using up as quickly as possible.
-

# Installation Precautions

## WARNING



- Do not install the machine in a place close to fire.
- Do not place flower vases, pots, cups, containers containing cosmetics, chemicals or water, or small metal items on or close to the machine. If they enter the machine, there is a risk of failure, electric shock, or fire.



- Do not install this machine in humid locations or locations where it may be exposed to splashing water. Otherwise there is a risk of failure, electric shock, or fire.



- Do not install the machine in a place where children may enter.



- When disabling safety functions (such as interlocks) during installation or maintenance, be sure to check and follow all warning instructions described in each procedure beforehand. Improper handling may result in serious personal injury.

## CAUTION



- A ventilation system must be provided if the machine is installed in a poorly ventilated area or sealed room.
- Be sure to observe the following points regarding exhaust port installation:
  - (1) Exhaust port installation must conform to local environmental, health, and safety (EHS) guidelines.
  - (2) If the exhaust port is fitted with a shutoff valve, the valve must be open when the machine is in use.

## NOTICE



- Do not install the machine in a dusty location. Dust ingress inside the machine increases the risk of failure or ejection failures (e.g., nozzle clogging or deflection).
- Do not install the machine where it is exposed to drafts, such as near an air conditioner. This increases the risk of dust ingress inside the machine.
- Do not install the machine in unstable locations or locations subject to vibration. This increases the risk of failure or ejection failures (such as nozzle clogging or deflection).
- Do not install the machine in a location subject to direct sunlight.
- Do not install the machine in a location subject to extreme temperature fluctuations. This increases the risk of failure or ejection failures (such as nozzle clogging or deflection).
- Do not install the machine in a location where large equipment generating noise is situated.
- Do not install the machine in locations where photographic fixing agent vapors, acid fumes (such as acetic acid or hydrochloric acid), cutting fluid, or other volatile substances (such as amines or modified amine alcohol) are present. Installing in such environments increases the risk of ink solidifying on the print head surface, causing failure or ejection failures (e.g., nozzle clogging or deflection).



- Operating environment: 20 to 30 °C (68 to 86 °F), 35 to 65 %RH (no condensation)
- Temperature range in which accuracy is guaranteed: 20 to 25 °C (68 to 77 °F)

## Installation Space

Provide the following space around the machine to allow safe and proper replacement of ink and media:

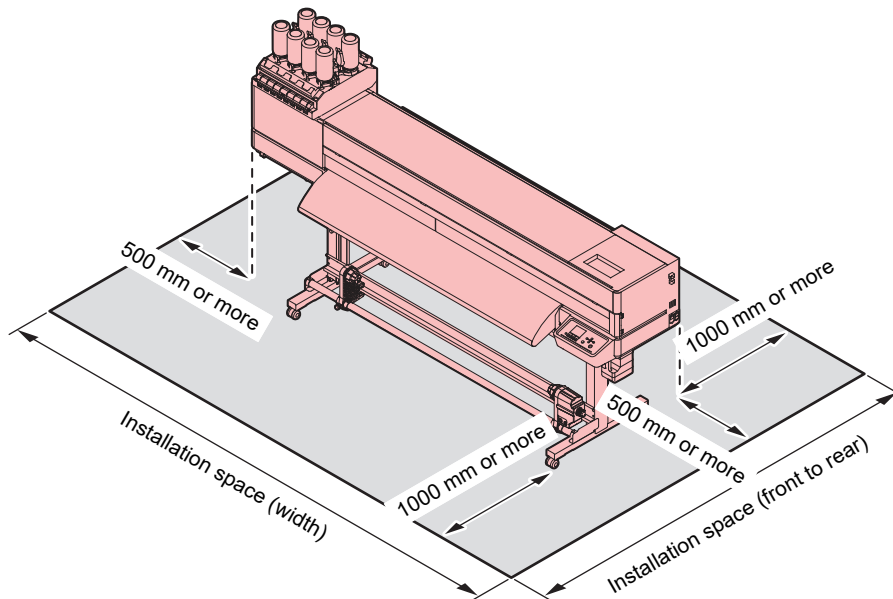

Size	130	160
Width <sup>*1</sup>	At least 3,520 mm (2,520 mm)	At least 3,770 mm (2,770 mm)
Depth <sup>*1</sup>	At least 2,748 mm (748 mm)	
Height <sup>*1</sup>	(1,405 mm)	
Weight	(155kg)	(160kg)

\*1. The figures in parentheses indicate machine dimensions excluding ink bottles.

## When relocating the machine

Contact your local dealer or our service office. There is a risk of failure or damage to the machine if you try to move it yourself.

# Safety Interlocks

The machine is equipped with interlocks to ensure safety during use.

Printing will abort if you open the covers while printing is underway. The RIP data will need to be resent.

- Safety interlock locations

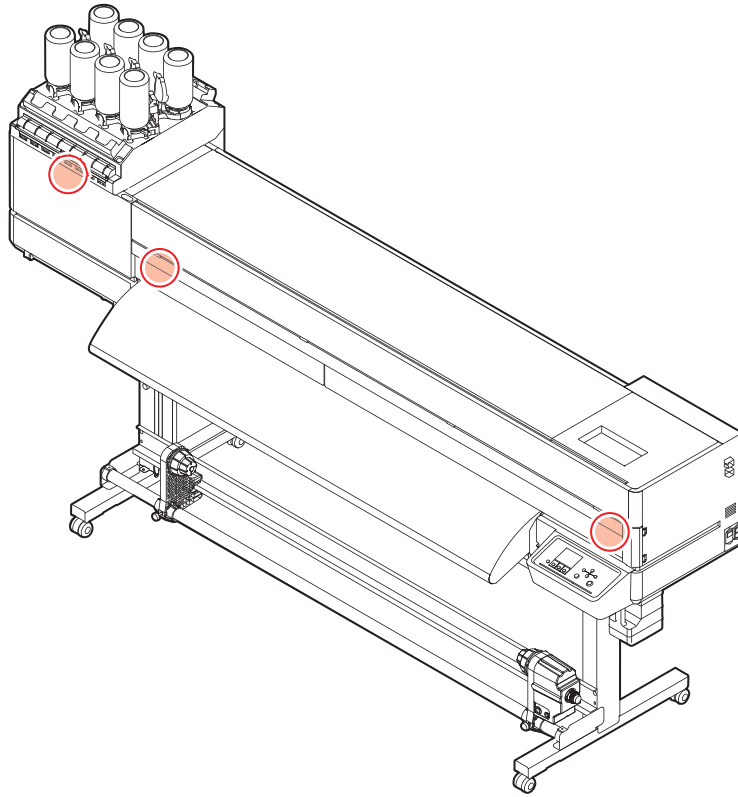







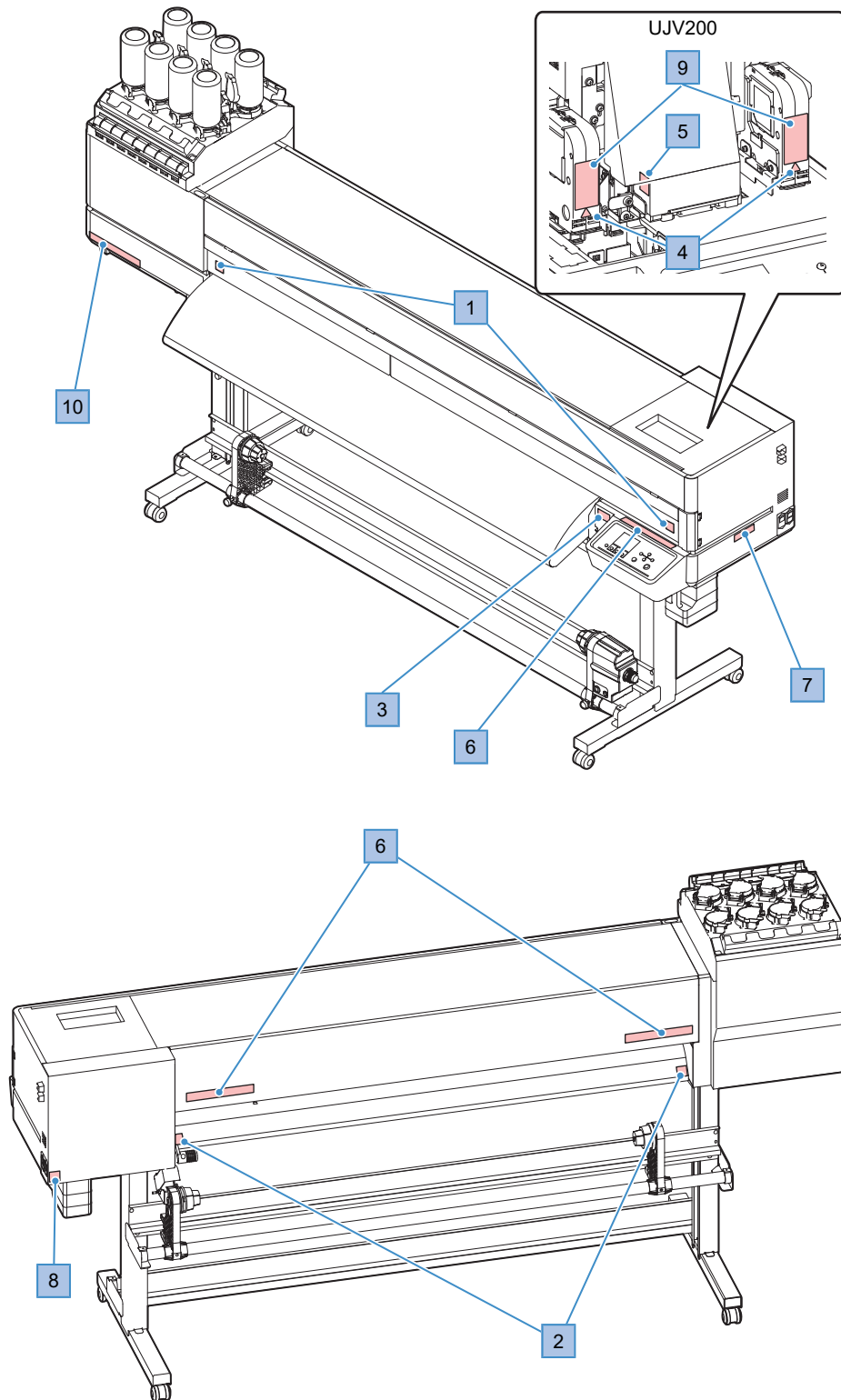









# Warning Label

Make sure you fully understand the details indicated on the various warning labels.

If any of the warning labels becomes dirty and illegible or peel off, contact your local dealer or our service office to request new warning labels.



No.	Order code	Label	Details														
1	M907833		Indicates dangerous moving parts. Be careful not to put your hand in while the power is on, as you may hit the moving parts and injure yourself.														
2	M903239		Indicates hot parts. Do not touch the heater while it is energized as it may cause burns.  • Preheater														
3	M903330		Wear safety glasses and gloves while working as ink may adhere to them.														
4	M919855		Indicates hot parts. Do not touch the heater while it is energized as it may cause burns.  • Head unit (unit of measurement in decibel) • UV units (right, left)														
5	M903405		Be careful with the cutter as it may cause injury.														
6	M905811	 <table border="1" data-bbox="512 1025 975 1099"> <tr> <td><b>警告</b></td> <td><b>警告</b></td> <td><b>WARNING</b></td> <td><b>WAARSCHUWING</b></td> <td><b>AVERTISSEMENT</b></td> </tr> <tr> <td>手指和身体請勿靠近运转部位，以免造成危險</td> <td>危險な稼働部 指や体近づかないように</td> <td>HAZARDOUS MOVING PARTS Keep fingers and other body parts away.</td> <td>GEFÄHRLICHE BEWEGLICHE TEILE Finger und andere Körperteile fernhalten.</td> <td>PIECES MOBILES DANGEREUSES Doigts et autres parties du corps sont hors de portée.</td> </tr> </table>	<b>警告</b>	<b>警告</b>	<b>WARNING</b>	<b>WAARSCHUWING</b>	<b>AVERTISSEMENT</b>	手指和身体請勿靠近运转部位，以免造成危險	危險な稼働部 指や体近づかないように	HAZARDOUS MOVING PARTS Keep fingers and other body parts away.	GEFÄHRLICHE BEWEGLICHE TEILE Finger und andere Körperteile fernhalten.	PIECES MOBILES DANGEREUSES Doigts et autres parties du corps sont hors de portée.	Indicates dangerous moving parts. Touching it with the power on may cause injury.				
<b>警告</b>	<b>警告</b>	<b>WARNING</b>	<b>WAARSCHUWING</b>	<b>AVERTISSEMENT</b>													
手指和身体請勿靠近运转部位，以免造成危險	危險な稼働部 指や体近づかないように	HAZARDOUS MOVING PARTS Keep fingers and other body parts away.	GEFÄHRLICHE BEWEGLICHE TEILE Finger und andere Körperteile fernhalten.	PIECES MOBILES DANGEREUSES Doigts et autres parties du corps sont hors de portée.													
7	M916035	<table border="1" data-bbox="440 1133 924 1267"> <tr> <td></td> <td>This unit has two power cords. For removal of all power, disconnects both cords. Cet appareil a deux cordons secteur. Pour le mettre hors tension, débranchez ces deux cordons secteur. 本機は、2本の電源ケーブルがある。電源をオフする場合、2本とも抜くこと。</td> </tr> </table>		This unit has two power cords. For removal of all power, disconnects both cords. Cet appareil a deux cordons secteur. Pour le mettre hors tension, débranchez ces deux cordons secteur. 本機は、2本の電源ケーブルがある。電源をオフする場合、2本とも抜くこと。	Describes the power cable. Please observe the notes for your safety.												
	This unit has two power cords. For removal of all power, disconnects both cords. Cet appareil a deux cordons secteur. Pour le mettre hors tension, débranchez ces deux cordons secteur. 本機は、2本の電源ケーブルがある。電源をオフする場合、2本とも抜くこと。																
8	M907935		Indicates dangerous live parts. Do not touch the product while it is energized to avoid risk of electric shock.														
9	M920199	<table border="1" data-bbox="534 1435 831 1995"> <tr> <td></td> <td><b>WARNING</b> <b>AVERTISSEMENT</b> 警告</td> </tr> <tr> <td></td> <td></td> </tr> <tr> <td><b>ULTRAVIOLET RADIATION</b> <b>RAYONS ULTRAVIOLETS</b> 紫外線放出 紫外线照射</td> <td></td> </tr> <tr> <td>Ultraviolet Radiation. When exposed to ultraviolet, there is a risk of blindness or burns.</td> <td></td> </tr> <tr> <td>Rayonnements UltraViolet. Exposition dangereuse pour l'oeil et la peau. Peut provoquer la cécité et des brûlures</td> <td></td> </tr> <tr> <td>紫外線が照射されています。紫外線を浴びると失明や火傷の恐れがあります。</td> <td></td> </tr> <tr> <td>紫外线照射注意 紫外线接触会有失明 或者烧伤的可能性</td> <td></td> </tr> </table>		<b>WARNING</b> <b>AVERTISSEMENT</b> 警告			<b>ULTRAVIOLET RADIATION</b> <b>RAYONS ULTRAVIOLETS</b> 紫外線放出 紫外线照射		Ultraviolet Radiation. When exposed to ultraviolet, there is a risk of blindness or burns.		Rayonnements UltraViolet. Exposition dangereuse pour l'oeil et la peau. Peut provoquer la cécité et des brûlures		紫外線が照射されています。紫外線を浴びると失明や火傷の恐れがあります。		紫外线照射注意 紫外线接触会有失明 或者烧伤的可能性		Beware of ultraviolet light. Note that there is a UV irradiation device inside the equipment.
	<b>WARNING</b> <b>AVERTISSEMENT</b> 警告																
																	
<b>ULTRAVIOLET RADIATION</b> <b>RAYONS ULTRAVIOLETS</b> 紫外線放出 紫外线照射																	
Ultraviolet Radiation. When exposed to ultraviolet, there is a risk of blindness or burns.																	
Rayonnements UltraViolet. Exposition dangereuse pour l'oeil et la peau. Peut provoquer la cécité et des brûlures																	
紫外線が照射されています。紫外線を浴びると失明や火傷の恐れがあります。																	
紫外线照射注意 紫外线接触会有失明 或者烧伤的可能性																	

No.	Order code	Label	Details
10	PA001-S		When opening the cover, be careful not to be directly under the cover. Disregarding this precaution may cause the machine to slide and result in injury.

## **Safety precautions**

---

---

April, 2026

**MIMAKI ENGINEERING CO.,LTD.**

2182-3 Shigeno-otsu, Tomi-shi, Nagano 389-0512 JAPAN

---

---

D203922-11-30042026

